

A New Approach in Daylighting Design for Buildings

Nguyen H. Phuong

Faculty of Electrical and Electronics Engineering, HCMC University of Technology and Education, Vietnam

nguyenhoangphuong@tgu.edu.vn (corresponding author)

Luan D. L. Nguyen

Faculty of Electrical and Electronics Engineering, HCMC University of Technology and Education, Vietnam | Center for Energy Consultancy and Energy Auditing, University of Architecture Ho Chi Minh City, Vietnam

luan.nguyenleduy@uah.edu.vn

Vu H. M. Nguyen

Center for Energy Consultancy and Energy Auditing, University of Architecture Ho Chi Minh City, Vietnam

evu.nguyenhoangminh@uah.edu.vn

Vo. V. Cuong

Faculty of Electrical and Electronics Engineering, HCMC University of Technology and Education, Vietnam

evu.nguyenhoangminh@uah.edu.vn

Tran M. Tuan

University of Architecture Ho Chi Minh City, Vietnam

tuan.tranminh@uah.edu.vn

Pham A. Tuan

Department of Urban Planning, University of Architecture Ho Chi Minh City, Vietnam

tuan.phamanh@uah.edu.vn

Received: 20 February 2023 | Revised: 25 May 2023, 29 May 2023, and 5 June 2023 | Accepted: 9 May 2023

Licensed under a CC-BY 4.0 license | Copyright (c) by the authors | DOI: <https://doi.org/10.48084/etasr.5798>

ABSTRACT

Daylighting is a future building design trend, subjected to all the global energy efficiency standards, but its design still largely depends on the architect and it is difficult for electrical engineers to precisely quantify the energy efficiency of the solution. This study presents an innovative integration process of design and simulation, rooted in the parameters of existing standards and regulations, and leveraging architectural design and simulation software tools. Within this novel integrated design methodology, the peripheral zones of the building envelope and the central core areas of the structure are discretely conceptualized and designed. Daylight intensity in the building envelope's peripheral zones is calculated based on the average daylight factor and the building's optimized window-to-wall ratio. In contrast, the central core areas are designed to attract daylight from open spaces on the roof, roof structure, reflective roofs, and clerestories. A building energy performance simulation tool is utilized to validate the energy efficiency of these new design techniques. This fresh approach is tested on a complex pilot-scale building in Nhon Trach, Dong Nai, Vietnam, to evaluate the method's feasibility and scientific soundness. The simulation results corroborate the accuracy of the proposed approach in quantifying the efficiency of reducing a building's lighting system energy consumption by 34%, equivalent to an annual CO₂ saving of over 4,000 tons.

Through the proposed daylighting design, an approximate 7% increase incurs in total initial investment, promising substantial profitable returns.

Keywords-daylighting; building; daylighting design; energy efficiency; CO₂ emissions

I. INTRODUCTION

The 2021 UN Climate Change Summit concluded successfully with the establishment of various significant objectives, amongst which the swift and sustainable reduction of CO₂ emissions was a key priority. The design of daylighting in buildings – a technique that harnesses and controls the entry of natural light into a building to optimize visual and thermal comfort, energy efficiency, environmental friendliness, while generating a congenial ambiance for the occupants – was acknowledged [1]. This technique has a long history, dating back to times before artificial lighting technology existed. Le Corbusier underscored the importance of daylighting in architecture with the statement, "The history of architecture is the history of the struggle for light" [2]. However, the prominence of daylighting dwindled during the latter half of the 19th century, as architectural designs began to predominantly rely on artificial light sources.

Artificial lighting systems' energy consumption constitutes between 20 and 40% of total energy use in commercial and office buildings [3], ranging between 20 and 40 kWh/m²/yr [4]. In terms of residential applications, lighting accounts for nearly 19% of total residential power consumption worldwide, with the share of lighting being about 25% in China homes, 9% in US homes, 17% in 15 state-members of the EU, and 13% across all 28 EU countries. Such consumption levels render artificial lighting in buildings responsible for approximately 5% of global CO₂ emissions [5]. To curb this proportion and address the energy crisis since the 1970s, numerous studies focusing on daylighting solutions have been undertaken and published over the last fifty years. Many methods and models for predicting and computing building daylighting supply, technologies and design techniques for building daylighting, and simulation tools have emerged during the recent years. There are now 42 daylighting tools implemented globally, assisting lighting designers in precisely estimating the quantity of daylighting for buildings over time. A total of 91% of these tools are integrated with efficient design solutions, reducing buildings' artificial lighting system energy consumption by 21-38% [6]. With the rising concern over greenhouse gases and climate change, daylighting has gained increased prominence and is progressively becoming a mandatory specification in building design worldwide, as seen in standards like LEED (USA), BREEAM (UK), CASBEE (Japan), Green Mark (Singapore), and LOTUS (Vietnam). It is perceived as a long-term development trend. However, a vital question arises: What constitutes an appropriate design process to facilitate electrical engineers and lighting designers in their integration of lighting design with daylighting, thereby meeting the requirements of various standards?

This study introduces an innovative process that integrates design and simulation, grounded in the criteria of contemporary regulations and harnessing building design and simulation software tools. The practicality of this novel design process is exhibited through representative application studies. The

elements of the proposed process are elucidated succinctly and extensively, with particular emphasis placed on the most critical content, presented in detail with explicit guidelines.

II. METHODOLOGY

The daylighting solution for a building is a product that depends on the natural characteristics of the building's location. Therefore, the daylighting solution for each project and each location must demonstrate a scientifically sound analysis and evaluation. The methodology, process and content of the daylighting design for a building are shown in Figure 1 [19].

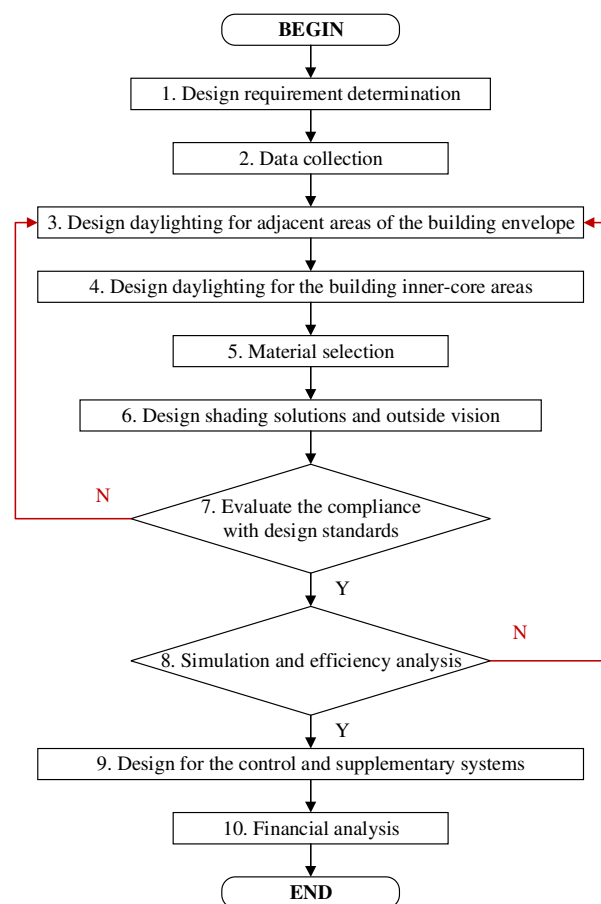

Fig. 1. Proposed flowchart of the design process.

A. Determination of Design Requirements

Depending on the characteristics and actual data of the building, the design parameters to consider may include some of the following: (1) Daylight Autonomy (DA), (2) Spatial Daylight Autonomy (SDA), (3) Continuous Daylight Autonomy (CDA), (4) Useful Daylight Illuminance (UDI), (5) Daylight Availability (DA), (6) Daylight Factor (DF), (7) Mean Hourly Illuminance (MHI), (8) Energy Use Intensity (EUI), (9)

Uniformity Ratio (UR), (10) Lighting Power Density (LPD), (11) Window-to-Wall Ratio (WWR), (12) Visible Light Transmission (VLT), (13) Solar Heat Gain Coefficient (SHGC), (14) Overall Heat Transfer Coefficient (OHTC), (15) Shading Coefficient (SC), (16) general information of the construction, and (17) the investor's requirements.

B. Data Collection

While the first step is mainly to collect general information, the second step involves collecting detailed and specific information about the construction site, building materials, construction parameters, electrical and other equipment parameters, simulation tools, and construction investment costs.

C. Design Daylighting for the Area Adjacent to the Building Envelope

In order to select window types and determine room parameters, window areas and the arrangement of the light-incident space, it is necessary to calculate the average DF (DF_{ave}) (1) and the optimized WWR (3) for the building [7]:

$$DF_{ave} = \frac{V_T \cdot A_{CS} \cdot \theta}{A_S \cdot (1 - R^2)} \quad (\%) \quad (1)$$

$$R = \frac{S_W \cdot R_W}{A_S} + \frac{S_C \cdot R_C}{A_S} + \dots \quad (2)$$

$$WWR = \frac{A_{CS}}{A_S} \quad (\%) \quad (3)$$

where V_T denotes the visible transmittance (according to standards or manufacturer parameters), A_{CS} is the total area of the entire glass envelope of the building [m^2], θ is the maximum available light reception angle [$^\circ$], A_S represents the total of walls, windows, ceilings, and floors of the building [m^2], R is the reflection coefficient based on surface, calculated using the formula (2), S_W, R_W denote the area and reflection coefficient of building walls, respectively [m^2], and S_C, R_C are the area and reflection coefficient of the building walls, respectively [m^2]. If DF_{ave} is greater than 5%, the design space will be fully illuminated with natural light. If DF_{ave} is between 2% and 5%, the design space is illuminated with moderate daylight and if it is less than 2%, the design space does not meet the minimum daylighting requirements. In this case, additional artificial light must be used.

These two values can easily be calculated and simulated by design software. In addition, WWR can be looked up directly in international/national standards.

Some proposed daylighting design techniques for buildings are: (1) Using continuous glass strips on the wall to optimize light efficiency instead of individually separable doors, (2) using low-emissivity (Low-E) laminated glass to eliminate external thermal radiation and reduce energy consumption for indoor air-conditioning, (3) use of mobile shading systems to separate the glass from the glass for daylighting to ensure the view from inside the building to the outside, (4) limitation of large sized windows to ensure controllability and uniform natural lighting throughout the building, (5) use of sloping ceilings to increase window height, (6) prioritizing horizontal glass windows over vertical ones to optimize the distribution of natural light, (7) use of fixed and mobile shading solutions and

light redirection solutions to direct light deeper into the building, (8) prohibiting large-format furniture to block natural light from entering the building, and (9) avoid using dark colors on the building's walls, ceilings and floors, as this significantly reduces the reflection coefficient but increases the radiation absorption coefficient.

D. Design Daylighting for the Building Inner-Core Areas

To bring natural light deep into the core of the building, many solutions have been introduced and applied to projects around the world. The solutions focus on techniques for exploiting the light from the roof and the application of light guide systems with optical materials on the building. Especially in low-rise buildings or attics, the solution of exploiting the light from the roof (skylight) is often used. Light guide solutions with optical systems are often applied to effectively use the natural light from the roof and sides of the building. From a technical point of view, there are two proposed strategies for daylighting in the core area: (1) The daylighting strategy with sloping skylights and horizontal side windows, and (2) the daylighting strategy with clerestories and flat roofs. The first prioritizes the use of natural light with high luminous flux and high illuminance through skylights or dome windows placed on the building roof. All forms of skylights including flat skylights, dome skylights, sloping skylights, and triangular (pyramidal) skylights have the ability to directly absorb sunlight. However, the problem of radiant heat entering the building is still a major obstacle to this strategy. Some of the recommended techniques for this strategy include:

- If the building does not have side windows, solutions must be designed so that the distances between skylights/flat roof windows are equal to the distance from the finished floor to the ceiling (see Figure 2).
- If the building has side windows, adding natural light through the windows will reduce the number of skylights (see Figure 3).
- Use of skylights for pitched roofs when the building is erected in a place where there is a large difference in solar radiation between summer and winter.
- In order to increase the scattering angle, it is possible to design the ceiling structure at the installation location of the skylight, in particular the skylight with corner bracket to expand the scattering angle into the room below (see Figure 4(a)).

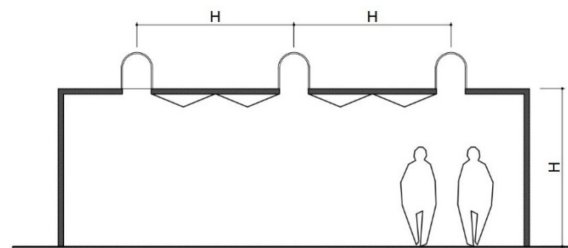

Fig. 2. Relationship between skylights and building height (case without side windows).

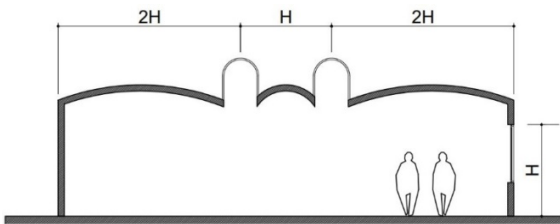

Fig. 3. Relationship between skylights and building height (case with side windows).

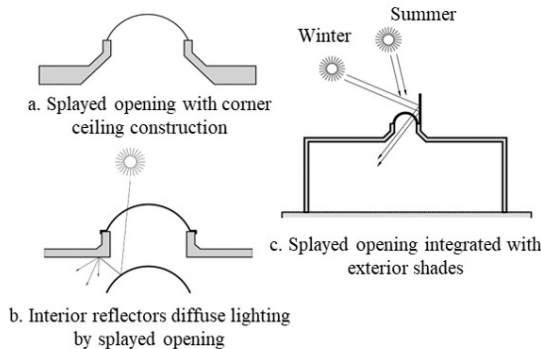

Fig. 4. Techniques for harnessing daylight through domed skylights.

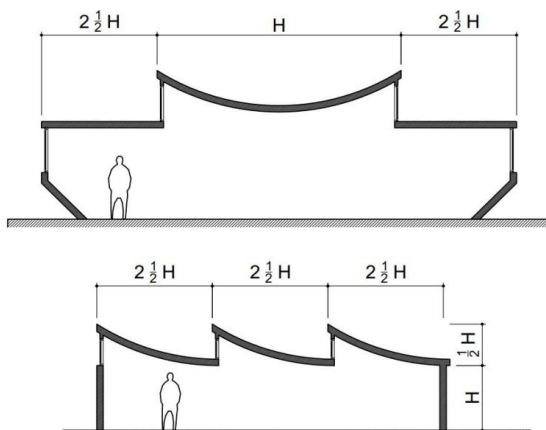

Fig. 5. Distance of the clerestories compared to the height of the building.

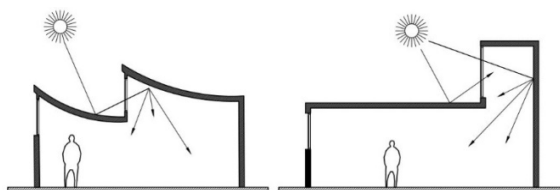

Fig. 6. Solution with a reflective roof and use of the inner-wall as a reflective plane.

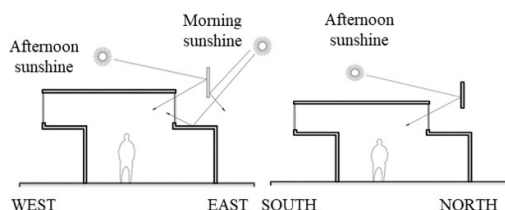

Fig. 7. Solutions using daylight trap for unfavorable directional windows.

- To optimize the efficiency of the use of natural light from skylights, roof windows, or active the navigation of natural light in the building core, they can be supplemented by shading structures or reflectors (see Figure 4(b)). Diffused reflectors can also be used under skylights and roof windows to spread natural light far into the surrounding spaces (see Figure 4(c)).

- Effort must be done to increase the ceiling height to minimize direct glare, since the light is already diffused when it reaches the user's field of view.

Solutions to this strategy are widespread globally, particularly in temperate and sub-temperate countries, as they make efficient use of the natural light from their less common sources of radiation. However, there are not many construction projects in Vietnam that use these lighting solutions.

The lighting strategy with clerestories and flat roof proposes solutions to prioritize the use of tall vertical or near-vertical windows instead of horizontal and arched windows on the traditional roof. The aim of these solutions is to reduce the direct heat entering the building. Clerestories are oriented to the north or south and have different structures: Doors to the south are usually designed as canopies or clerestories, while the north doors are typically sloped to maximize the natural light entering the building while minimizing glare. This strategy includes the following solutions:

- Turn the door to the South or North to maximize the light entering the building and limit heat radiation.
- The distance between the doors should be as shown in Figure 5.
- Use reflective roofs to diffuse and spread the light around the building. This solution helps limit glare and provides light with moderate luminous flux and soft light emission. The reflective roof also helps to significantly reduce heat radiation (Figure 6(a)).
- Use the interior surface of the building envelope as a reflection plane to the inside of the building. This solution requires the wall surface material to have a high reflection coefficient or be installed with external reflectors/devices to reflect the light into the room and spread it horizontally [8] (Figure 6(b)).
- Use external solar collectors to support the west and east cliffs. These devices improve the ability to capture light from the sun and transmit it to the doors. However, from an architectural point of view, clerestories facing west and east are not recommended (Figure 7).

Along with the previous solution sets, solutions to this strategy are widespread around the world due to the natural light efficiency provided by the sunlight. In Vietnam, however, these lighting solutions are not used in many buildings.

E. Material Selection

Natural light can be captured and introduced into the building through transmittance materials or the creation of openings on the surface of the building's side walls and roof, as opposed to the building surface with traditional dense concrete

blocks. Therefore, when choosing windows, glass materials and building envelope materials, care should be taken to focus on transmittance and glass materials used for the building envelope. Material properties to study and consider during the material selection include: (1) OHTC, (2) VLT, and (3) SHGC [9]. These parameters are also considered when the building uses shading solutions, in order to assess the influence of shading solutions and material properties on the ability to transmit light into the building. These values differ depending on the country standard [9].

F. Design Shading Solutions and Outside Vision

Shading solutions not only prevent and limit the penetration of direct sunlight into the building, but also direct the light deep into the building core. At the same time, they also regulate the direction of the light and the intensity of the solar radiation to create a natural sense of well-being. Not every building requires a shading solution, however, shading structures can detract from the building's aesthetics and ruin the architectural intent if not incorporated into the design from the start. The sole purpose of shading solutions is usually to protect buildings from direct sunlight, especially those facing West. Therefore, the design of shading solutions, if not an idea integrated into the architectural aesthetics, has only one purpose, namely to shade the sun in directions unfavorable to the building. Depending on the current situation and the needs of the building, the designer may propose a suitable solution for shading and visibility.

G. Evaluating the Compliance with Design Standards

One has to ensure the selection of window types, window and glass materials in accordance with energy efficiency standards, looking for the specified thresholds as a basis for selection, and creating checklists regarding whether the selection of window types and window and glass materials complies with the regulations, because in practice there are cases when each material meets the norm, but when all the materials are combined, the overall value does not comply with the standard.

H. Simulation and Efficiency Analysis

Design simulations is a complex task, but necessary to evaluate the efficiency of a daylighting solution for a building at the design stage. Energy simulation programs are powerful tools not only to evaluate the ultimate efficiency of a solution, but also to analyze a building's daylighting potential during the concept phase. They also allow designers to use the software's databases to make many assumptions and change specifications for different types of windows, materials, and blinds without manually collecting data from external markets. Another great advantage of using design simulation software is the optimization of the design solution, which can help the designer to find a way to optimize his solution in terms of the technical comfort of the energy industry. Software tools can use their big data combined with machine learning and artificial intelligence algorithms to quickly optimize design solutions. The most commonly used effective simulation software tools are: Dialux, Lightsolve, RADIANCE, ADELIN, Rayfront, Ecotect, CODYRUN, DAYSIM, DOE-2.1, Photopia, BIM-based Simulation Tool (on Revit,

RADIANCE and DAYSIM platforms), EnergyPlus, LightTool/SolidWorks, IES VE (6.1.1), Relux, SkyCalc, Autodesk VIZ 4, SPOT, Lightscape, RadioRay, and Microstation. Some software tools specialized in calculating the daylight coefficient are Lightscape, RadioRay, Microstation, and Relux. There are tools that can simulate all parameters of daylighting, including control parameters. Widespread daylight simulation software tools include: Luxicon, Visual, AGi32, Dialux Evo, Relux, Ecotect, Lumion and Revit. Each software tool has its own strengths and is suitable for certain types of lamps, glass, and building materials [10].

I. Design for the Control and Supplementary Systems

Since the sun's movement is continuous and daylight is inherently unstable, natural illuminance changes continuously during the day. Therefore, in order to ensure stable lighting during certain works, the daylighting system must be combined with an artificial electric lighting system and other control supporting devices such as sensors and automatic blinds. These additional systems are called daylighting control systems or additional and integrated systems. These systems include:

- The artificial lighting system in the building supporting the daylight system when the natural illuminance does not meet the work requirements.
- Artificial lighting control that controls the luminous flux of the artificial lamp (dimming) based on the continuous change in the natural luminous flux over the course of the day. To accomplish this task, the artificial lighting control system must include the following components: (1) Components for recording and quantifying the change in luminous flux in the installation space, (2) components that receive information about the change in luminous flux in the installation space and use a control algorithm to stabilize it, and (3) components for adjusting the amount of luminous flux emitted by artificial lamps. These components are directly connected together to form a complete system as shown in Figure 8.
- Control system for shading solution: Controls the operation of the building's mobile shading solutions such as curtains, blinds, and external curtains.
- Integrated system of the building envelope, shading solutions, and artificial light control: A solution for coordinating light and heat regulation systems such as building envelope, shading solutions, and daylight automation in one integrated system.

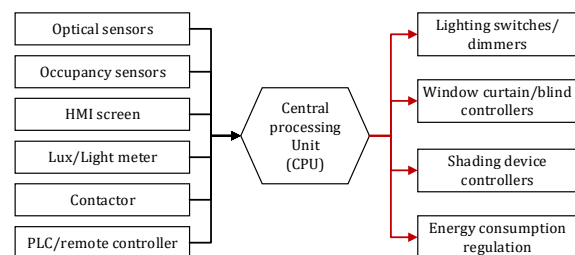

Fig. 8. Structure of the artificial lighting control.

J. Financial Analysis

The efficiency of a project is assessed based on two criteria: (1) Financial efficiency and (2) socioeconomic efficiency. In doing so, financial efficiency can be checked more quantitatively, faster, and more precisely than socio-economic efficiency, which requires more time to collect and verify data. Three common methods of assessing a project's financial indicators include: (1) Calculating the Net Present Value (NPV), (2) determination of the simple payback period, and (3) determination of the Internal Rate of Return (IRR). The financial assessment results show varying levels of accuracy depending on the accuracy and scope of the input data.

III. SIMULATIONS, RESULTS, AND DISCUSSION

To specify the proposed natural lighting design process, a typical daylighting design is implemented according to the steps of the proposed method for a selected building. Each step of the process clarifies the building information and the basis for the reasoning, calculation, parameter selection, and energy efficiency simulation.

A. Design Requirement Determination

The information about the project is shown in Table I.

TABLE I. BUILDING INPUT DATA

Data	Description	Value
Location	Nhon Trach District, Dong Nai Province	
Building's description	Multifunctional building (office, small mechanical workshop, and commercial services) reinforced concrete structure, 20mm thick plastered brick wall, 20 mm thick foam insulation roof.	
Storys		01
Dimensions (L×W×H)	(80 × 32 × 14) m	
Gross Floor Area (GFA)		2560 m ²
Total Envelope's Area (TEA)		3136 m ²
Work's requirements	Meticulous and accurate tasks	
Shading ratio	No shading	0%

B. Data Collection

Necessary data include: (1) Direction, (2) coordinates, (3) solar data on site, (4) architectural drawings and design perspective, (5) design illuminance standards, (6) parameters of designed transmittance materials, (7) electrical equipment and sensor parameters, (8) simulation tools and simulation data sets.

1) Direction and Coordinates

The façade of the building faces north, the main axis of the building is north-south. Table 2.20 from [11] shows that the intensity of solar radiation and direct radiation is the highest on the east and south-east façades. In the afternoon, these values gradually shift to the west and south-west façades. The sun path in the month with the highest sunshine hours is in Figure 9.

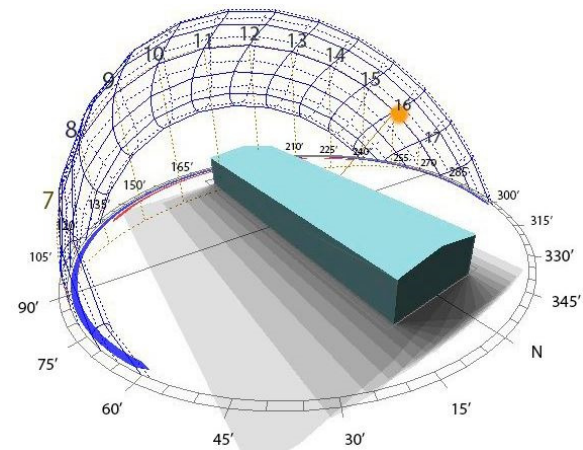

Fig. 9. Sun path diagram at the construction site in June.

2) Solar Data on the Construction Site

The building was built at low latitudes, near the equator. The average number of sunshine hours was 4 to 11 per day. The annual number of hours of sunshine was 2500. The intensity of solar radiation increased rapidly from sunrise to 2:00 p.m. and decreased rapidly from 2:00 p.m. until sunset. The annual temperature variation had two peaks in April and August and two minimums in December and June, meaning that the sun reached its zenith and its lowest level twice in a year. The solar data were retrieved from the simulation free commercial software DIALux Evo.

3) Architectural Drawings and Design Perspective of the Building

The building consisted of 1 floor with the plan and shapes as shown in Figure 10. These drawings were reconstructed in the simulation software.

4) Design Lighting Standards

As the construction is in Vietnam, the lighting design standards are based on the Vietnamese Technical Regulations [12-13]. The lighting design of a building consists of natural and artificial lighting. These values are listed in Table II.

5) Parameters of Transmittance Materials

The building used double-glazed Low-E glass for the main doors and windows. Double glazing has been used on the front and rear to maximize the natural light in the building. If this information were used for selecting material in the simulation software, the simulation results would have the exact parameters of the material [14].

6) Parameters of Electrical Lighting Devices and Sensors

Light-Emitting Diodes (LEDs) and photo sensors were prioritized to quantify solar luminous flux, and transmit signals to a processing center to adjust lamp luminous flux. In addition, occupancy sensors were installed throughout most of the building to detect the presence of workers and to control the switching on and off of the lighting in the building.

TABLE II. DESIGN ILLUMINATION STANDARDS

Room number	Functionality	Artificial lighting	Daylighting ratio
		E_{min} (lux)	(%)
101	Lobby	100	1.5
102	Living room 1	200	5.0
103	Living room 2	200	5.0
104	Meeting room 1	500	3.0
105	Testing room	500	5.0
106	Testing's staff room	500	5.0
107	Group meeting room	300	3.0
108	Server room	200	3.0
109	Print, photocopy room 1	300	3.0
110	Product storage room	200	2.0
111	Main meeting room	500	3.0
112	Electrical engineering room	200	5.0
113	Kitchen	200	2.0
114	Document storage room	100	1.0
115	Men WC	75	1.0
116	Women WC	75	1.0
117	RnD department	400	5.0
118	Testing, RnD, automatic cut room	500	5.0
120	Laser cutter and sewing workshop	1000	>5.0
121	Pump engineering room	200	2.0
122	Design and construction dept.	500	5.0
123	Product storage	300	2.0
124	Sample material storage	300	2.0
125	Financial accounting room	500	3.0
126	Print, photocopy room 2	300	3.0
127	Office	400	5.0

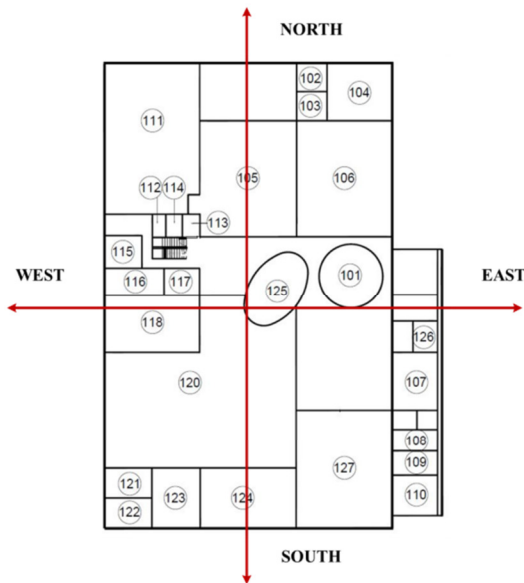

Fig. 10. Floor plan of the functional area of the building.

C. Design Daylighting for the Adjacent Areas of the Building Envelope

The new building had a reinforced concrete structure, 20 mm thick plastered brick walls and a 20 mm thick foam insulation roof. Because the eastern half of the building was an office area in which the employees worked regularly during the day, the western half of the building consists of the main hall, workshop, and research areas with low staff attendance. The daylighting solution is shown in Figures 12-14.



Fig. 11. Perspective drawing.

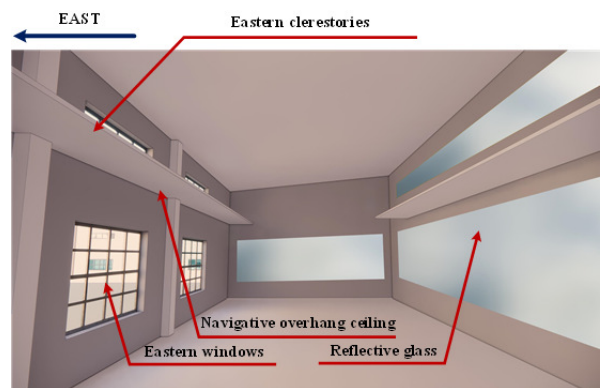

Fig. 12. Daylighting solution on the East side.

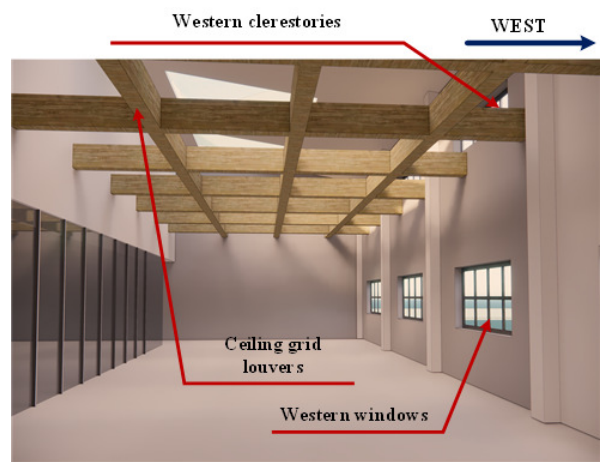

Fig. 13. Daylighting solution on the West side.

D. Design Daylighting for the Building Inner-Core Areas

As the building is up to 32 m wide, it was difficult for the core area of the building to get natural light from the facade and two sides of the building. Therefore, it was necessary to get daylight from the roof. The proposed solution was to use skylights with integrated optical sensors (sunoptics) measuring 2.4 m x 1.2 m to receive sunlight directly into the core. Since the height of the building was quite large (10 m – 12 m) and the height from the working plane to the roof was about 9.2 m to 11.2 m, most of the sunlight was scattered down onto the working plane, which limits the glare from direct radiation. However, it was also necessary to utilize the underlying

technical infrastructure and interior finishes to limit the glare and naturally shade the area below. The layout plan of the solar sunoptics on the roof is shown in Figure 15. The daylight effect in the core area was simulated. Based on the simulation results, the locations that did not meet the minimum requirements for design lighting were supplemented with artificial lighting. Automatic controls were used to synchronize the two systems.

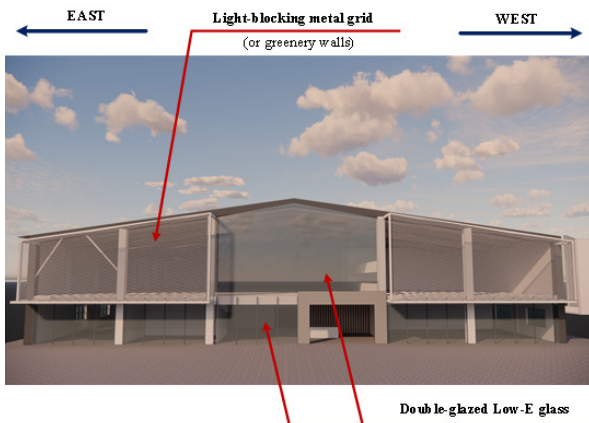

Fig. 14. Daylighting solution at the building's facade.

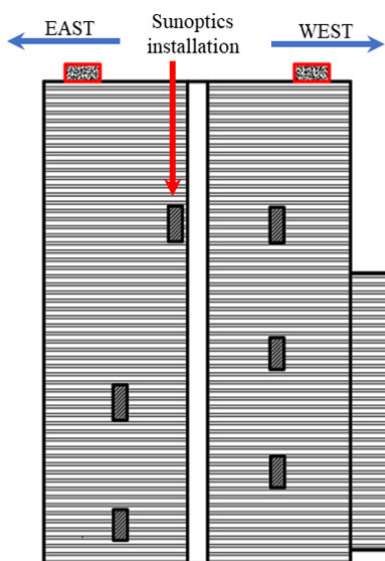

Fig. 15. Solution for arranging sunoptics on the roof of the building.

E. Material Selection

Double-glazed Low-E glass was used for the main doors and windows of the building. Double glazing has been used on the front and back to maximize the natural light entering the building.

F. Design Shading Solution and Outside Vision

Due to the use of double-glazed Low-E glass with insulating function for the side windows and clerestories on the east and west sides of the building, no shading solutions were used on the outside of the building, only local blinds were

positioned inside the doors, close to the door and manually operated according to the needs of the user.

G. Evaluation of the Compliance with the Design Standards

The total opening area of the four sides of the building is 628.38 m², the WWR was 20%. This result meets most of the requirements of green building standards worldwide including Vietnamese national regulations. The required parameters of the glass materials are listed in Table III [9].

TABLE III. DESIGN ILLUMINANCE PARAMETERS

WWR %	SHGC _{max} based on installed direction			VTI _{min}
	North	East	West	
20	0.9	0.8	0.8	0.7

H. Simulation and Efficiency

The simulation results using the DIALux Evo of the building's natural lighting at 7:00 am, 9:00 am, 3:00 pm, and 5:00 pm are shown in Figures 16-18. The results showed that at 7:00 am., the building areas with east-facing windows and entrance/exit door received natural light with relatively good illuminance (over 300 lux), the north facade of the building received diffused light with an average illuminance of 130 - 150 lux. Areas with west-facing windows of the building still received diffused light with insignificant illumination (in the range of 100 lux). Most of the other areas, especially the core areas of the building, received little direct daylight. The natural lighting from diffused light inside the building was around 30 - 50 lux.

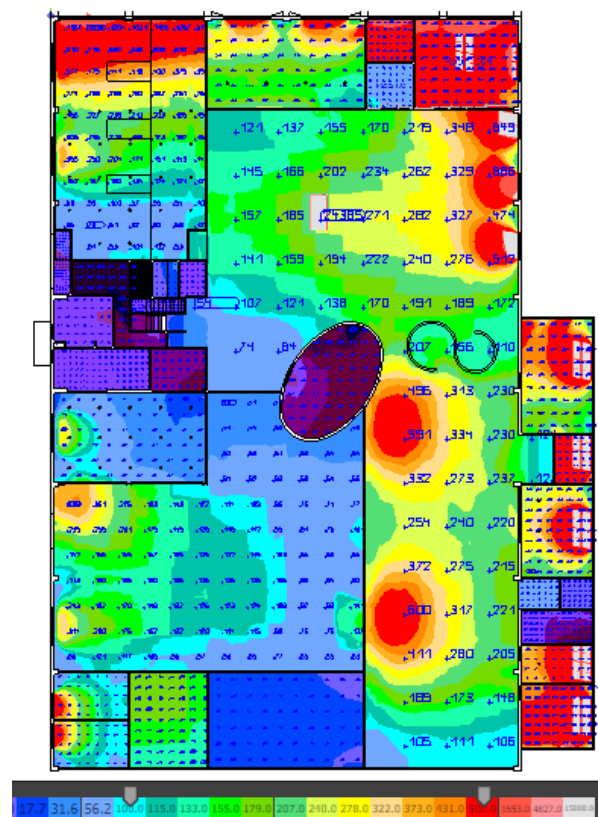

Fig. 16. Result of the building simulation at 9:00 am.

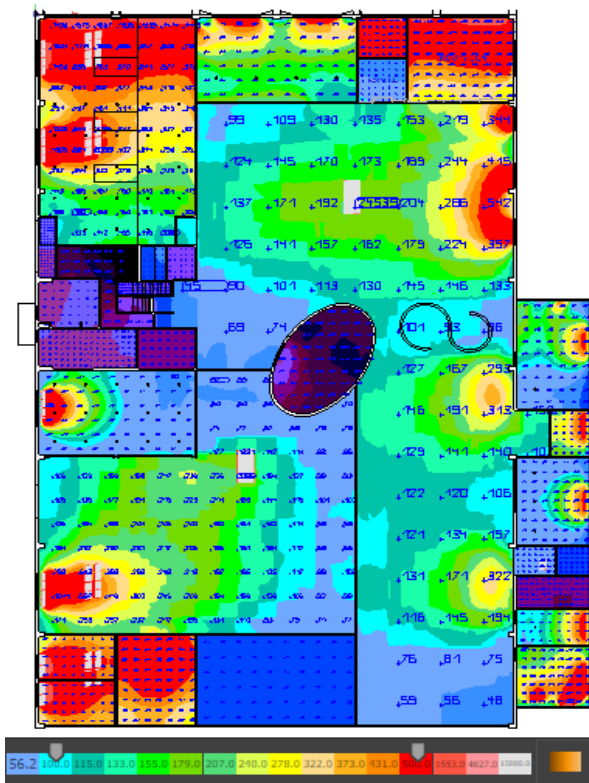

Fig. 17. Result of the building simulation at 3:00 pm.

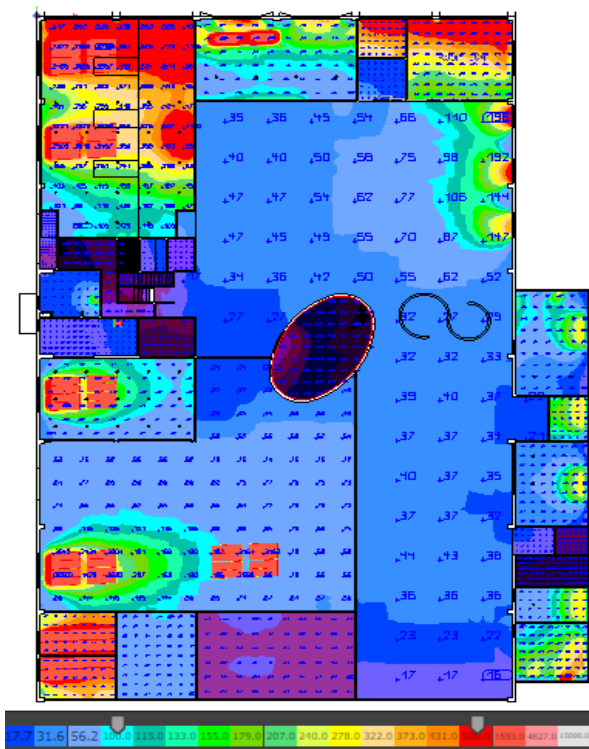

Fig. 18. Result of the building simulation at 5:00 pm.

Around 9:00 am, daylight penetrated with great intensity and the degree of natural light propagation into the core of the

building also increased significantly. The natural illuminance on the east-facing windows of the building ranged from 450 to 900 lux. The areas with the north facade of the building also achieved a quite high illuminance (over 400 lux). Especially in areas with sunoptics installed on the roof, the natural light illuminance increased significantly and reached over 600-1000 lux. The average illuminance in the core area also increased to over 120 lux compared to 30 - 50 lux at 7:00 am. Some areas still needed natural light.

Around 3:00 pm, the natural light illuminance in the eastern half of the core dropped sharply, illuminance at the window positions dropped below 500 lux, the sunoptics positions also sank to a steady state below 200 lux. On the other hand, the illuminance in the areas with west-facing window rose sharply and reached over 400 lux.

In the afternoon, the natural illuminance in the eastern half-core area of the building quickly fell to zero. From 5:00 pm, the western window areas of the building also began to receive reduced natural light, with average illuminance levels down to 200-300 lux. Most of the building's core received no natural light, while the northern facade still received some diffused light from the glass surface received in the facade.

The simulation results show that the rooms with windows on the east and west sides of the building achieve sufficient illuminance levels for half a day or a full day. The north facade receives plenty of daylight throughout the day. The summary table of the simulation results is shown in Table IV.

TABLE IV. SIMULATION RESULTS

Category	Full day daylighting in 100% of the area	Daylighting in 100% of the area in a period of time		Daylighting in 30% to 50% of the area in a period of time
		7:00 – 9:00	15:00 – 17:00	
Room	102, 104	106, 109	121, 122, 123	101, 105, 107, 111, 118, 120, 127

I. Design of Control and Supplementary Systems

Based on the simulation results combined with a functional analysis of the building areas, it was necessary to design the following additional systems.

1) Artificial Lighting System for the Building

The case study involves a multifunctional building comprised of offices, co-working spaces, production workshops, and warehouses. These areas exhibit distinct operational hours and activities. Office spaces and co-working areas function during regular business hours, from 7:00 am to 5:00 pm. In contrast, the production area might require extended work hours into the night, whereas the warehouse operates on a flexible schedule, less active than the other areas but capable of round-the-clock operation if necessary. The architectural layout shows that nearly the entire region adjacent to the East is utilized for office purposes, while over half of the area bordering the West accommodates factories, save for the low-frequency usage meeting room. Supplemental artificial lighting is primarily implemented under unfavorable daylight conditions or during nocturnal operations.

2) Luminous Flux Control System Integrated with Sunoptics

In terms of the natural conditions in the considered building site, the intensity of daylight during daytime varies continually but never diminishes below 70% of the average daily daylight intensity [11]. Therefore, the proposed lighting design strategy endeavors to maximize natural daylight, utilizing sunoptics installed on the roof and windows positioned on the lateral sides of the building. If the daylight illumination fails to provide sufficient lighting for work activities, the artificial light system's brightness intensity will be adjusted by dimmer rheostats through a multi-functional DIM-controller to ensure a stable level of required illuminance. The system's control principle, taken from [15], is depicted in Figure 19.

3) Occupancy Sensor System for Switching the Building Lighting System On and Off

An occupancy sensor system is installed to monitor the presence of staff or workers with two primary functions: (1) Activating or deactivating light fixtures in the room corresponding to the presence or absence of individuals in areas illuminated by those lights. This capability aims to prevent energy waste in scenarios where only a few individuals are working in a specific corner or a small area of the room, thereby negating the need to illuminate the entire room, (2) turning off all the lights in the room when it is unoccupied, or when the last individual leaves the room but neglects to switch off the lights.

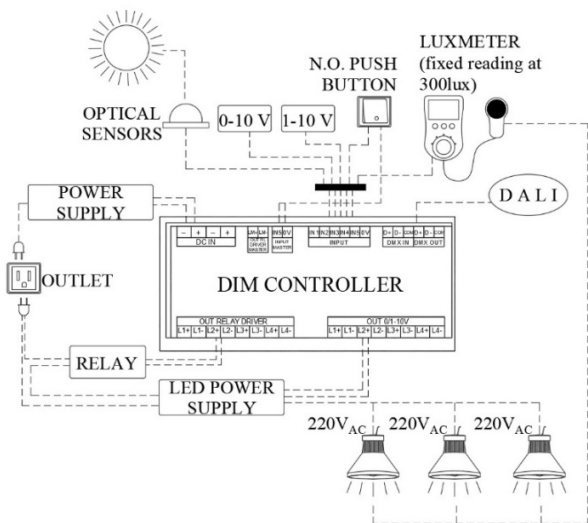

Fig. 19. Mechanism of the lumen control system integrated with sunoptics.

J. Financial Analysis

To analyze the financial efficiency of natural lighting solutions for the project under consideration, a simple financial analysis method based on standard investment costs is proposed. This method is based on the maximum normalized costs prescribed for all state budget construction works on the territory of Vietnam. The incurring costs, including consulting and design costs, as well as ancillary legal costs are not included in this investment ratio. Accordingly, when natural lighting solutions are added to the typical construction, the capital cost increases by 7% due to: (1) the cost of replacement

glass for traditional brick walls, (2) the costs of sunoptic devices and sensors, and (3) additional capital costs for the control system. These costs are listed in Table V. The difference in cost to replace the traditional brick wall area with glass is negligible and is therefore not included in this financial analysis. Since most of the global standards for energy efficiency in buildings always give the rules for the standard consumption value of the consumption per unit, this is also applied to calculate the standard electricity consumption for the project. It also contains the current electricity tariff for calculating the consumption costs under normal conditions and the costs to be paid after applying the daylight method in the building. The cost difference is the basis for assessing the profitability of the project. Another part of the revenue from CO₂ emission reductions is also taken into account when calculating the payback period of the project. In Table V, the annual consumption of the building lighting system is calculated using the maximum illuminance values regulated in the national technical regulation on energy efficient buildings. The simulation results show that the reduction in electricity consumption is about 34% of the total annual consumption of the lighting installation. At an average retail electricity tariff of US\$ 0.083 per kWh [16], the net savings from implementing the daylighting solution are approximately US\$ 2,323.3 per year. With a proposed exhaust gas ratio of 143 g-C/kWhe [17], the annual CO₂ reduction is about 4002.9 tons/yr. The payback period of the project is 9 months and 10 days.

TABLE V. FINANCIAL ANALYSIS OF THE SUGGESTED SOLUTION

Calculation factor	Result	Unit	Ref.
Std. construction investment cost	184.3	USD/m ²	[18]
Total initial investment of project	471,784.2	USD	
Increased investment by daylighting	33,024.9	USD	
Annual power consumption of the lighting system of the building	82,329.6	MWh	[19], Tab.I
Annual reduction in the power consumption of the lighting system	27,992.1	MWh	
Annual saving from power reduction	2,323.3	USD	
Annual reduction of CO ₂ emission	4002.9	ton-C/kWhe	
Price of CO ₂	10.02	USD/ton	[20]
Total income by CO ₂ transactions	40,109.1	USD	
Payback period	0.78	yr	

IV. REMARKS AND CONCLUSION

This paper proposes a new integrated design-simulation process based on the requirements of the global trend towards the energy efficiency in buildings, especially in lighting systems. The proposed design process is based on the following factors: (1) Lighting design trends that are environmentally friendly and reduce the building's energy consumption, (2) development of IT and software tools, and (3) large databases of natural conditions and current environment (including data from field surveys and measurements, data from software databases, and data released with government regulations). Each step in the proposed design process is analyzed and its role, responsibilities and benefit is clarified. Depending on the project, the needs of the investor and the judgment of the designer, some steps in the above process can

be skipped as long as the proposed solution allows users to quantify energy, investment, and healthcare efficiency.

The proposed design methodology enables electrical engineers and lighting designers to simulate the precise quantity of daylight entering spaces within a building. In this advanced integrated design approach, the bordering zones of the building envelope and the internal core areas of the structure are treated as separate entities and are designed accordingly. The daylight intensity in the peripheral zones of the building envelope is computed, taking into consideration the average daylight factor and the building's optimized window-to-wall ratio. Conversely, the internal core areas are subjected to strategies devised to attract daylight from traditional open spaces of the buildings' roof.

The approach proposed in this study mandates that designers establish a daylighting strategy and ascertain the level of daylight before proceeding with the design of artificial lighting. This necessitates the quantification of the variability in daylight intensity within the design space, akin to analyzing the degree of change in daylight intensity over time in correlation with local natural and hydrometeorological conditions. The proposed daylighting design strategy of this novel methodology is guided by two constraints: (1) the daylighting coefficient as per local standards and (2) the window-to-wall ratio in accordance with general international standards. This distinguishes the proposed method from the luminous flux method and the DIALux software's calculation method as these two methods only encompass these constraints: minimum illuminance (in line with design standards) and the luminous flux utilization factor (of the calculation method). This difference is a unique aspect of the proposed approach. The secondary distinction of the proposed methodology from the others rests in the utilization of architectural structures as a means to control daylight intensity. This necessitates an accurate computation of the amount of daylight absorbed by these structures during the design process. The other two methods overlook this factor in their design process

DIALux Evo is complimentary commercial simulation software that enables to visually simulate and evaluate designs. The primary objective of this study is to demonstrate the capability of DIALux Evo in providing designers with a comprehensive suite of tools aiming to enhance the precision of their daylighting design

The new approach will be implemented on a complex building in Nhon Trach, Dong Nai, Vietnam to assess the feasibility and scientific validity of the method. This pilot project is designed step by step according to the process and complies with the current technical regulations for the energy efficiency in buildings in Vietnam. The result is expected to show the efficiency of reducing the energy consumption for the lighting system in the building by 34%, saving more than 4,000 tons of CO₂ per year and bringing significant profit, since the payback time is only 9 months and 10 days.

ACKNOWLEDGEMENT

This work is funded by the Ho Chi Minh City University of Technology and Education (HCMUTE) and is supported by the

Vietnamese Ministry of Construction (MOC) under the Scientific Research Program. We would like to thank all those responsible at the MOC and the colleagues at HCMUTE and the University of Architecture Ho Chi Minh City, Vietnam, for their tireless support.

REFERENCES

- [1] C. Reinhart, *Daylighting Handbook I: Daylight with Sun – Fundamentals – Design with Sun*. New York, NY, USA: Muscle Nerve, 2014.
- [2] F. Moore, *Concepts and Practice of Architectural Daylighting*. New York, NY, USA: John Wiley & Sons, 1991.
- [3] G. N. Tiwari, A. Tiwari, Shyam, *Handbook of Solar Energy, Energy Systems in Electrical Engineering*, Singapore: Springer, 2016.
- [4] F. Leccese, F. Fantozzi, V. Vandelanotte, G. Salvadori, M. Rocca, and T. Corucci, "Energy Consumption, Operating Costs and CO₂ Emission of LED Lighting in Office Building," in *Proceedings of the 15th CIRIAF National Congress on Environmental Footprint and Sustainable Development*, Perugia, Italy. April, 2015
- [5] G. N. Gugul, and M. A. Koksak, "Some Insights to the Lighting Electricity Consumption of Turkish Households," in *Proceedings of the 9th International Conference on Energy Efficiency in Domestic Appliances and Lighting (EEDAL'17) – Part III*, pp. 1161-1170.
- [6] M. E. Aizlewood and P. J. Littlefair, "Daylight prediction methods: a survey of their use," UK, Technical Report ETSU-S/O-2/00098/REP; BRE-CR-125/94, Apr. 1994.
- [7] *TCXD 29:1991, Natural lighting in civil works – Design standard*, Ministry of Science and Technology, Vietnam, 1991.
- [8] A. S. Mahmoud, "Overview of Green Roof Technology as a Prospective Energy Preservation Technique in Arid Regions," *Engineering, Technology & Applied Science Research*, vol. 12, no. 4, pp. 8982–8989, Aug. 2022, <https://doi.org/10.48084/etasr.4919>.
- [9] *QCVN 09:2013/BXD, National technical regulation on energy efficiency buildings*, Ministry of Construction, Vietnam, 2013.
- [10] A. Zerroug and E. Dzelzitis, "A Study of Modeling Techniques of Building Energy Consumption," *Engineering, Technology & Applied Science Research*, vol. 10, no. 1, pp. 5191–5194, Feb. 2020, <https://doi.org/10.48084/etasr.3257>.
- [11] *QCVN 02:2022/BXD, National technical regulation on Natural Physical and Climatic Data for Construction*, Ministry of Construction, Vietnam, 2022.
- [12] *QCVN 12:2014/BXD, National technical regulation on electrical installations of dwelling and public buildings*, Ministry of Construction, Vietnam, 2014.
- [13] *Circular 22/2016/TT-BYT, National technical regulations on lighting – Permissible workshop illuminance*, Ministry of Health, Vietnam, 2016.
- [14] A. Belkadi, D. Mezghani, and A. Mami, "Energy Design and Optimization of a Greenhouse: A Heating, Cooling and Lighting Study," *Engineering, Technology & Applied Science Research*, vol. 9, no. 3, pp. 4235–4242, Jun. 2019, <https://doi.org/10.48084/etasr.2787>.
- [15] "Lighting control and control gear," in *The Lighting Handbook*, 6th ed., Dornbirn, Austria: Zumtobel Lighting GmbH, 2018, pp. 102–139.
- [16] *Decision No. 648/QĐ-BCT dated on March 20, 2019, Decision on adjustment of average electricity retail price and regulations on electricity price*. Ministry of Industry and Trade, Vietnam.
- [17] V. V. Cuong, *Journal of Science and Technology*, vol. 79, pp. 102–107, 2010.
- [18] *Decision No. 65/QĐ-BXD dated on January 20, 2021, Decision promulgating the rate of work construction investment capital and general construction price of structural parts in 2020*. Ministry of Construction, Vietnam.
- [19] *LOTUS certification system*, Vietnam Green Building Council (VGBC), Vietnam, 2019.
- [20] *Effective Carbon Rates 2021*. OECD, 2021.